

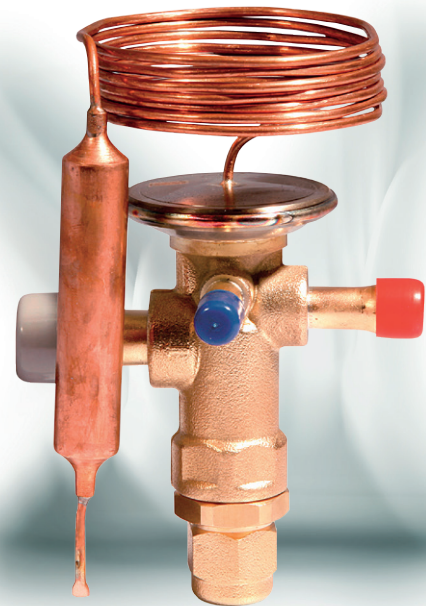

Thermostatic Expansion Valve

RFGD series thermostatic expansion valves are used to adjust mass flow of refrigerant into the evaporator while controlling the refrigerant's superheat at the outlet of the evaporator. They can be used for various refrigerants under all working conditions. Typical applications are refrigeration systems like commercial refrigerators and freezers, icemakers, dehumidifiers as well as air conditioners at various evaporation temperatures.



FEATURES

- COMPACT DESIGN WITH BUILD-IN ORIFICE
- WARM THERMO HEAD CONSTRUCTION
- ALL CONNECTIONS PIPES ARE COMPLETELY IN COPPER
- VALVES WITH MOP FUNCTION CAN BE PROVIDED TO ASSURE RELIABLE COMPRESSOR OPERATION
- APPLICABLE IN A WIDE EVAPORATION TEMPERATURE RANGE
- RELIABLE AND CONSISTENT PERFORMANCE OF SUPERHEAT CONTROL
- BALANCED PORT - SUITABLE FOR REVERSIBLE CYCLES
- THERMAL BULB UTILIZES CROSS CHARGE TECHNOLOGY, PROVIDING CONSISTENT SUPERHEAT DEGREE OVER THE WHOLE EVAPORATION TEMPERATURE RANGE
- WIDE CAPACITIES RANGE SPLIT IN 9 ORIFICES SIZES:
RFGD10: (orifices 1 to 6)
RFGD20: (orifices 7 to 9)

GENERAL SPECIFICATION

- Applicable for all common HCFC and HFC refrigerants such as: R22, R134a, R404A, R407C, R410A, R507
- Ambient temperature min./max.: -35/+55°C
- Medium temperature TS min./max.: -40°C / +70°C
- Max. operating pressure PS: 4.8 Mpa
- Installation position:
 - Preferably valve head upwards
 - Main flow direction from inlet A to outlet B
- Certifications: UL/CSA and PED declaration

1) Max. operating pressure is related to the used refrigerant



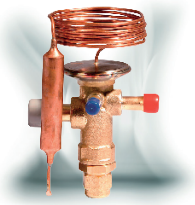

SANHUA RFGD SERIES Thermostatic Expansion Valve

TECHNICAL PARAMETERS

- RFGD valves are available in straight shape with adjustable superheat on site
- RFGD valves are available with the different solder and flare connections (see more details in following tables)
- RFGD valves are available with 3 different temperature ranges:
 - from -40°C to +10°C
 - from -25°C to +10°C
- Equalization port available as option:
 - Metric: 6mm ODF
(available for models with metric solder connections)
 - Imperial: 1/4" ODF
(available for models with imperial solder connections)
- Capillary tube length 1500mm as standard. Different length customizable on request.
- Standard MOP values:
 - T. range -40°C to +10°C: MOP: +15°C or MOP not present
 - T. range -25°C to +10°C: MOP: +15°C

MODEL DESIGNATION LEGEND

Position Number	Model Designation Legend	
1	Product Code	Product Series
	RFGD	Thermostatic expansion valve with build-in orifice
2	Refrigerant	Description
	1	R22
	2	R407C
	3	R404A / R507
	4	R134a
	5	R410A
3	Pressure Equalization	Description
	E	External pressure equalization
	(Omitted)	Internal pressure equalization
4	Valve Size	Internal Orifice Size
	From 1 to 9	Valve size: proportional to the orifice size and to the nominal capacity



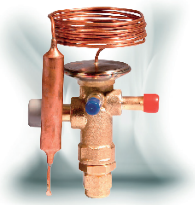

SANHUA RFGD SERIES Thermostatic Expansion Valve

MODEL DESIGNATION LEGEND

Position Number	Model Designation Legend	
5	Connections Type	Description
	M10/16	Metric: inlet 10mm / outlet 16mm
	M12/22	Metric: inlet 12mm / outlet 22mm
	M16/22	Metric: inlet 16mm / outlet 22mm
	3/5	Imperial: inlet 3/8" / outlet 5/8"
	4/7	Imperial: inlet 1/2" / outlet 7/8"
	5/7	Imperial: inlet 5/8" / outlet 7/8"
	S5/6	Both SAE Flare: inlet 5/8" / outlet 3/4"
	I5/6	Both MIO Flare: inlet 5/8" / outlet 3/4"
	O5/6	Both ORFS inlet 5/8" / outlet 3/4"
6	Miscellaneous	Description
	xxx	Digits for additional information e.g. temperature range, MOP, Bleed...

MODEL DESIGNATION EXAMPLE

Position Number						According to Model Designation Legend
1	2	3	4	5	6	
RFGD	04	E	3	M16/22	xxx	Thermostatic expansion valve with build-in orifice
RFGD	04	E	3	M16/22	xxx	Refrigerant: R134a
RFGD	04	E	3	M16/22	xxx	With connection for external pressure equalization
RFGD	04	E	3	M16/22	xxx	Capacity: Valve and orifice size 3
RFGD	04	E	3	M16/22	xxx	Valve pipe connections: metric inlet 16mm/outlet 22mm
RFGD	04	E	3	M16/22	xxx	Digits for additional information



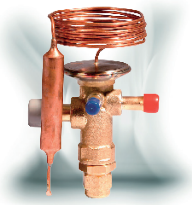

SANHUA RFGD SERIES

Thermostatic Expansion Valve

TECHNICAL DATA

Nominal Capacities ¹⁾

R22			R407C ²⁾			R404A / R507A			R134a			R410A		
Model Name ³⁾	Capacity		Model Name ³⁾	Capacity		Model Name ³⁾	Capacity		Model Name ³⁾	Capacity		Model Name ³⁾	Capacity	
	USRT	kW		USRT	kW		USRT	kW		USRT	kW		USRT	kW
RFGD 01-1	3,0	10,6	RFGD 02-1	3,1	10,9	RFGD 03-1	2,0	7,0	RFGD 04-1	1,8	6,3	RFGD 05-1	3,5	12,3
RFGD 01E-1			RFGD 02E-1			RFGD 03E-1			RFGD 04E-1			RFGD 05E-1		
RFGD 01-2	4,0	14,1	RFGD 02-2	4,2	14,8	RFGD 03-2	2,8	9,8	RFGD 04-2	2,5	8,8	RFGD 05-2	4,5	15,8
RFGD 01E-2			RFGD 02E-2			RFGD 03E-2			RFGD 04E-2			RFGD 05E-2		
RFGD 01-3	6,0	21,1	RFGD 02-3	6,3	22,2	RFGD 03-3	4,2	14,8	RFGD 04-3	3,6	12,7	RFGD 05-3	7,0	24,6
RFGD 01E-3			RFGD 02E-3			RFGD 03E-3			RFGD 04E-3			RFGD 05E-3		
RFGD 01-4	7,5	26,4	RFGD 02-4	8,1	28,5	RFGD 03-4	5,4	19,0	RFGD 04-4	4,6	16,2	RFGD 05-4	8,6	30,2
RFGD 01E-4			RFGD 02E-4			RFGD 03E-4			RFGD 04E-4			RFGD 05E-4		
RFGD 01-5	9,0	31,7	RFGD 02-5	9,4	33,1	RFGD 03-5	6,4	22,5	RFGD 04-5	5,5	19,3	RFGD 05-5	10,6	37,3
RFGD 01E-5			RFGD 02E-5			RFGD 03E-5			RFGD 04E-5			RFGD 05E-5		
RFGD 01-6	11,0	38,7	RFGD 02-6	11,7	41,1	RFGD 03-6	7,8	27,4	RFGD 04-6	6,8	23,9	RFGD 05-6	12,8	45,0
RFGD 01E-6			RFGD 02E-6			RFGD 03E-6			RFGD 04E-6			RFGD 05E-6		
RFGD 01-7	12,0	42,2	RFGD 02-7	12,0	42,2	RFGD 03-7	9,0	31,7	RFGD 04-7	8,0	28,1	RFGD 05-7	15,0	52,8
RFGD 01E-7			RFGD 02E-7			RFGD 03E-7			RFGD 04E-7			RFGD 05E-7		
RFGD 01-8	15,0	52,8	RFGD 02-8	15,0	52,8	RFGD 03-8	11,0	38,7	RFGD 04-8	10,0	35,2	RFGD 05-8	19,0	66,8
RFGD 01E-8			RFGD 02E-8			RFGD 03E-8			RFGD 04E-8			RFGD 05E-8		
RFGD 01-9	18,0	63,3	RFGD 02-9	18,0	63,3	RFGD 03-9	13,0	45,7	RFGD 04-9	12,0	42,2	RFGD 05-9	23,0	80,9
RFGD 01E-9			RFGD 02E-9			RFGD 03E-9			RFGD 04E-9			RFGD 05E-9		

- Note:**
- 1) Nominal capacities referred at the following working conditions:
 Condensing temperature: 38°C; evaporating temperature +4,4°C; Liquid temperature 37°C
 Static Super Heating: 4 K
 - 2) R407C data based on dew point conditions
 - 3) Model Name in this table is referred to the first 4 positions of the model designation



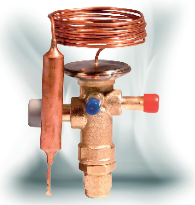

SANHUA RFGD SERIES

Thermostatic Expansion Valve

RFGD10 MODEL LIST

(with External Equalization) – Solder connection

Model Name										Temperature Range	
Refr.	Valve Body	Capacity Size All Sizes	Pipe connections Metric / Imperial	Inlet		Outlet		Pressure Equal.		-40°C to +10°C	-25°C to +10°C
				[mm]	[inch]	[mm]	[inch]	[mm]	[inch]	No MOP	MOP: +15°C
R22	RFGD 01E -	1 -	M10/16	10	-	16	-	6	-	O.R.	O.R.
		2 -	M12/22	12	-	22	-	6	-	O.R.	O.R.
		3 -	M16/22	16		22		6	-	O.R.	O.R.
		4 -	3/5	-	3/8	-	5/8	-	1/4	O.R.	O.R.
		5 -	4/7	-	1/2	-	7/8	-	1/4	O.R.	O.R.
		6 -	5/7		5/8		7/8	-	1/4	O.R.	O.R.
R407C	RFGD 02E -	1 -	M10/16	10	-	16	-	6	-	STD	O.R.
		2 -	M12/22	12	-	22	-	6	-	STD	O.R.
		3 -	M16/22	16		22		6	-	STD	O.R.
		4 -	3/5	-	3/8	-	5/8	-	1/4	STD	O.R.
		5 -	4/7	-	1/2	-	7/8	-	1/4	STD	O.R.
		6 -	5/7		5/8		7/8	-	1/4	STD	O.R.
R404A / R507	RFGD 03E -	1 -	M10/16	10	-	16	-	6	-	STD	O.R.
		2 -	M12/22	12	-	22	-	6	-	STD	O.R.
		3 -	M16/22	16		22		6	-	STD	O.R.
		4 -	3/5	-	3/8	-	5/8	-	1/4	STD	O.R.
		5 -	4/7	-	1/2	-	7/8	-	1/4	STD	O.R.
		6 -	5/7		5/8		7/8	-	1/4	STD	O.R.
R134a	RFGD 04E -	1 -	M10/16	10	-	16	-	6	-	STD	O.R.
		2 -	M12/22	12	-	22	-	6	-	STD	O.R.
		3 -	M16/22	16		22		6	-	STD	O.R.
		4 -	3/5	-	3/8	-	5/8	-	1/4	STD	O.R.
		5 -	4/7	-	1/2	-	7/8	-	1/4	STD	O.R.
		6 -	5/7		5/8		7/8	-	1/4	STD	O.R.
R410A	RFGD 05E -	1 -	M10/16	10	-	16	-	6	-	STD	O.R.
		2 -	M12/22	12	-	22	-	6	-	STD	O.R.
		3 -	M16/22	16		22		6	-	STD	O.R.
		4 -	3/5	-	3/8	-	5/8	-	1/4	STD	O.R.
		5 -	4/7	-	1/2	-	7/8	-	1/4	STD	O.R.
		6 -	5/7		5/8		7/8	-	1/4	STD	STD ¹⁾

DS-RFGD-EN-R1807 Copyright © SANHUA 2018 Subject to change without notice



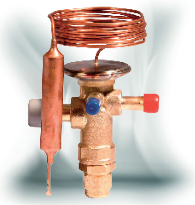

SANHUA RFGD SERIES

Thermostatic Expansion Valve

RFGD20 MODEL LIST

(with External Equalization) – Solder connection

Model Name										Temperature Range		
Refr.	Valve Body	Capacity Size All Sizes	Pipe connections Metric / Imperial	Inlet		Outlet		Pressure Equal.		-40°C to +10°C	-25°C to +10°C	
				[mm]	[inch]	[mm]	[inch]	[mm]	[inch]	No MOP	MOP: +15°C	
R22	RFGD 01E -	7 - 7 - 8 - 8 - 9 - 9 - 7 - 7 - 8 - 8 - 9 - 9 -	M16/22	16		22		6		O.R.	O.R.	
			M16/28	16		28		6		O.R.	O.R.	
			M16/28	16		28		6		O.R.	O.R.	
			M22/28	22		28		6		O.R.	O.R.	
			M22/28	22		28		6		O.R.	O.R.	
			M22/35	22		35		6		O.R.	O.R.	
			5/7		5/8		7/8		1/4		O.R.	O.R.
			5/9		5/8		1-1/8		1/4		O.R.	O.R.
			5/9		5/8		1-1/8		1/4		O.R.	O.R.
			7/9		7/8		1-1/8		1/4		O.R.	O.R.
			7/9		7/8		1-1/8		1/4		O.R.	O.R.
			7/11		7/8		1-3/8		1/4		O.R.	O.R.
R407C	RFGD 02E -	7 - 7 - 8 - 8 - 9 - 9 - 7 - 7 - 8 - 8 - 9 - 9 -	M16/22	16		22		6		STD	STD	
			M16/28	16		28		6		STD	STD	
			M16/28	16		28		6		STD	STD	
			M22/28	22		28		6		STD	STD	
			M22/28	22		28		6		STD	STD	
			M22/35	22		35		6		STD	STD	
			5/7		5/8		7/8		1/4		STD	STD
			5/9		5/8		1-1/8		1/4		STD	STD
			5/9		5/8		1-1/8		1/4		STD	STD
			7/9		7/8		1-1/8		1/4		STD	STD
			7/9		7/8		1-1/8		1/4		STD	STD
			7/11		7/8		1-3/8		1/4		STD	STD
R404A / R507	RFGD 03E -	7 - 7 - 8 - 8 - 9 - 9 - 7 - 7 - 8 - 8 -	M16/22	16		22		6		STD	STD	
			M16/28	16		28		6		STD	STD	
			M16/28	16		28		6		STD	STD	
			M22/28	22		28		6		STD	STD	
			M22/28	22		28		6		STD	STD	
			M22/35	22		35		6		STD	STD	
			5/7		5/8		7/8		1/4		STD	STD
			5/9		5/8		1-1/8		1/4		STD	STD
			5/9		5/8		1-1/8		1/4		STD	STD
			7/9		7/8		1-1/8		1/4		STD	STD

DS-RFGD-EN-R1807 Copyright © SANHUA 2018 Subject to change without notice



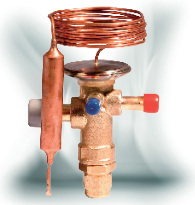

SANHUA RFGD SERIES

Thermostatic Expansion Valve

RFGD20 MODEL LIST

(with External Equalization) – Solder connection

Model Name										Temperature Range		
Refr.	Valve Body	Capacity Size All Sizes	Pipe connections Metric / Imperial	Inlet		Outlet		Pressure Equal.		-40°C to +10°C	-25°C to +10°C	
				[mm]	[inch]	[mm]	[inch]	[mm]	[inch]	No MOP	MOP: +15°C	
R404A / R507	RFGD 03E -	9 - 9 -	7/9		7/8		1-1/8		1/4	STD	STD	
			7/11		7/8		1-3/8		1/4	STD	STD	
R134a	RFGD 04E -	7 - 7 - 8 - 8 - 9 - 9 - 7 - 7 - 8 - 8 - 9 - 9 -	M16/22	16		22		6		STD	STD	
			M16/28	16		28		6		STD	STD	
			M16/28	16		28		6		STD	STD	
			M22/28	22		28		6		STD	STD	
			M22/28	22		28		6		STD	STD	
			M22/35	22		35		6		STD	STD	
			5/7		5/8		7/8		1/4		STD	STD
			5/9		5/8		1-1/8		1/4		STD	STD
			5/9		5/8		1-1/8		1/4		STD	STD
			7/9		7/8		1-1/8		1/4		STD	STD
			7/9		7/8		1-1/8		1/4		STD	STD
			7/11		7/8		1-3/8		1/4		STD	STD
R410A	RFGD 05E -	7 - 7 - 8 - 8 - 9 - 9 - 7 - 7 - 8 - 8 - 9 - 9 -	M16/22	16		22		6		STD	STD	
			M16/28	16		28		6		STD	STD	
			M16/28	16		28		6		STD	STD	
			M22/28	22		28		6		STD	STD	
			M22/28	22		28		6		STD	STD	
			M22/35	22		35		6		STD	STD	
			5/7		5/8		7/8		1/4		STD	STD
			5/9		5/8		1-1/8		1/4		STD	STD
			5/9		5/8		1-1/8		1/4		STD	STD
			7/9		7/8		1-1/8		1/4		STD	STD
			7/9		7/8		1-1/8		1/4		STD	STD
			7/11		7/8		1-3/8		1/4		STD	STD



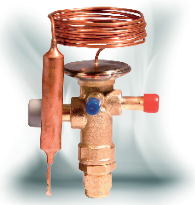

SANHUA RFGD SERIES Thermostatic Expansion Valve

RFGD20 MODEL LIST

(with External Equalization) – Flare connection

Model Name							Temperature Range	
Refr.	Valve Body	Capacity Size All Sizes	Pipe connections Metric / Imperial	Inlet	Outlet	Pressure Equal.	-40°C to +10°C	-25°C to +10°C
				[inch]	[inch]	[inch]	No MOP	MOP: +15°C
R134a	RFGD 04E -	7 - 7 - 7 - 8 - 8 - 8 - 9 - 9 - 9 -	M16/22				STD	STD
			M16/28				STD	STD
			M16/28				STD	STD
			M22/28				STD	STD
			M22/28				STD	STD
			M22/35				STD	STD
			5/7	5/8	7/8	1/4	STD	STD
			5/9	5/8	1-1/8	1/4	STD	STD
			5/9	5/8	1-1/8	1/4	STD	STD

- Note:**
- 1) Extent of delivery: valve body and bulb strap
 - 2) O.R. : On Request
 - 3) N.A.: Not Available
 - 4) STD: Standard Models available on stock (see Standard Model Table for further details)



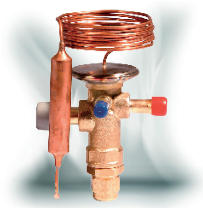

SANHUA RFGD SERIES

Thermostatic Expansion Valve

RFGD STANDARD RANGE

A) Models with Metric Connections

RFGD10 (orifice 1-6) -40°C to +10°C (Models without MOP)

Refr.	Valve Body	Capacity Size All Sizes	Connections IN x OUT		Pressure Equal.	Model Name	Product Number U11 Code Multi-Pack
			Metric	[mm]	[mm]		
R407C	RFGD 02E -	1 -	M10/16	10 x 16	6	RFGD 02E-3.1-57	10205009002
		2 -	M12/22	12 x 22	6	RFGD 02E-4.2-58	10205009102
		3 -	M12/22	12 x 22	6	RFGD 02E-6.3-59	10205009202
		4 -	M12/22	16 x 22	6	RFGD 02E-8.1-60	10205009302
		5 -	M16/22	16 x 22	6	RFGD 02E-9.4-61	10205009402
		6 -	M16/22	16 x 22	6	RFGD 02E-11.7-62	10205009502
R404A / R507	RFGD 03E -	1 -	M10/16	10 x 16	6	RFGD 03E-2.0-63	10205009602
		2 -	M12/22	12 x 22	6	RFGD 03E-2.8-64	10205009702
		3 -	M12/22	12 x 22	6	RFGD 03E-4.2-65	10205009802
		4 -	M12/22	16 x 22	6	RFGD 03E-5.4-66	10205009902
		5 -	M16/22	16 x 22	6	RFGD 03E-6.4-67	10205010002
		6 -	M16/22	16 x 22	6	RFGD 03E-7.8-68	10205010102
R134a	RFGD 04E -	1 -	M10/16	10 x 16	6	RFGD 04E-1.8-69	10205010202
		2 -	M12/22	12 x 22	6	RFGD 04E-2.5-70	10205010302
		3 -	M12/22	12 x 22	6	RFGD 04E-3.6-71	10205010402
		4 -	M12/22	16 x 22	6	RFGD 04E-4.6-72	10205010502
		5 -	M16/22	16 x 22	6	RFGD 04E-5.5-73	10205010602
		6 -	M16/22	16 x 22	6	RFGD 04E-6.8-74	10205010702
R410A	RFGD 05E -	1 -	M10/16	10 x 16	6	RFGD 05E-3.5-75	10205010802
		2 -	M12/22	12 x 22	6	RFGD 05E-4.5-76	10205010902
		3 -	M12/22	12 x 22	6	RFGD 05E-7.0-77	10205011002
		4 -	M12/22	16 x 22	6	RFGD 05E-8.6-78	10205011102
		5 -	M16/22	16 x 22	6	RFGD 05E-10.6-79	10205011202
		6 -	M16/22	16 x 22	6	RFGD 05E-12.8-80	10205011302



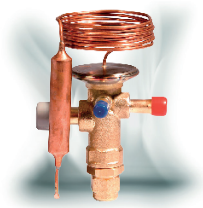

SANHUA RFGD SERIES

Thermostatic Expansion Valve

RFGD STANDARD RANGE

B) Models with Metric Connections

RFGD20 (orifice 7-9) -40°C to +10°C (Models without MOP)

Refr.	Valve Body	Capacity Size All Sizes	Connections IN x OUT		Pressure Equal.	Model Name	Product Number U11 Code Multi-Pack
			Metric	[mm]	[mm]		
R407C	RFGD 02E -	7 -	M16/22	16 x 22	6	RFGD02E-12.0-565	10205065202
		7 -	M16/28	16 x 28	6	RFGD02E-12.0-544	10205057502
		8 -	M16/28	16 x 28	6	RFGD02E-15.0-546	10205057702
		8 -	M22/28	22 x 28	6	RFGD02E-15.0-548	10205057902
		9 -	M22/28	22 x 28	6	RFGD02E-18.0-550	10205058102
		9 -	M22/35	22 x 35	6	RFGD02E-18.0-566	10205065302
R404A / R507	RFGD 03E -	7 -	M16/22	16 x 22	6	RFGD03E-9.0-563	10205066502
		7 -	M16/28	16 x 28	6	RFGD03E-9.0-534	10205056502
		8 -	M16/28	16 x 28	6	RFGD03E-11.0-536	10205056702
		8 -	M22/28	22 x 28	6	RFGD03E-11.0-538	10205056902
		9 -	M22/28	22 x 28	6	RFGD03E-13.0-540	10205057102
		9 -	M22/35	22 x 35	6	RFGD03E-13.0-564	10205065102
R134a	RFGD 04E -	7 -	M16/22	16 x 22	6	RFGD04E-8.0-559	10205066102
		7 -	M16/28	16 x 28	6	RFGD04E-8.0-503	10205054302
		8 -	M16/28	16 x 28	6	RFGD04E-10.0-515	10205054502
		8 -	M22/28	22 x 28	6	RFGD04E-10.0-521	10205054702
		9 -	M22/28	22 x 28	6	RFGD04E-12.0-523	10205054902
		9 -	M22/35	22 x 35	6	RFGD04E-12.0-560	10205066202
R410A	RFGD 05E -	7 -	M16/22	16 x 22	6	RFGD05E-15.0-567	10205065402
		7 -	M16/28	16 x 28	6	RFGD05E-15.0-552	10205058502
		8 -	M16/28	16 x 28	6	RFGD05E-19.0-553	10205058702
		8 -	M22/28	22 x 28	6	RFGD05E-19.0-554	10205058902
		9 -	M22/28	22 x 28	6	RFGD05E-23.0-556	10205059102
		9 -	M22/35	22 x 35	6	RFGD05E-23.0-568	10205065502



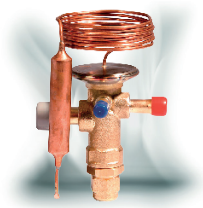

SANHUA RFGD SERIES

Thermostatic Expansion Valve

RFGD STANDARD RANGE

C) Models with Metric Connections

RFGD20 (orifice 7-9) -25°C to +10°C with MOP +15°C

Refr.	Valve Body	Capacity Size All Sizes	Connections IN x OUT		Pressure Equal.	Model Name	Product Number U11 Code Multi-Pack
			Metric	[mm]	[mm]		
R407C	RFGD 02E -	7 -	M16/22	16 x 22	6	RFGD02E-12.0-663	10205064702
		7 -	M16/28	16 x 28	6	RFGD02E-12.0-639	10205062802
		8 -	M16/28	16 x 28	6	RFGD02E-15.0-641	10205063002
		8 -	M22/28	22 x 28	6	RFGD02E-15.0-643	10205063202
		9 -	M22/28	22 x 28	6	RFGD02E-18.0-645	10205063402
		9 -	M22/35	22 x 35	6	RFGD02E-18.0-664	10205064802
R404A / R507	RFGD 03E -	7 -	M16/22	16 x 22	6	RFGD03E-9.0-661	10205066002
		7 -	M16/28	16 x 28	6	RFGD03E-9.0-629	10205061802
		8 -	M16/28	16 x 28	6	RFGD03E-11.0-631	10205062002
		8 -	M22/28	22 x 28	6	RFGD03E-11.0-633	10205062202
		9 -	M22/28	22 x 28	6	RFGD03E-13.0-635	10205062402
		9 -	M22/35	22 x 35	6	RFGD03E-13.0-662	10205064602
R134a	RFGD 04E -	7 -	M16/22	16 x 22	6	RFGD04E-8.0-657	10205065602
		7 -	M16/28	16 x 28	6	RFGD04E-8.0-603	10205059402
		8 -	M16/28	16 x 28	6	RFGD04E-10.0-605	10205059602
		8 -	M22/28	22 x 28	6	RFGD04E-10.0-607	10205059802
		9 -	M22/28	22 x 28	6	RFGD04E-12.0-609	10205060002
		9 -	M22/35	22 x 35	6	RFGD04E-12.0-658	10205065702
R410A	RFGD 05E -	7 -	M16/22	16 x 22	6	RFGD05E-15.0-665	10205064902
		7 -	M16/28	16 x 28	6	RFGD05E-15.0-649	10205063802
		8 -	M16/28	16 x 28	6	RFGD05E-19.0-651	10205064002
		8 -	M22/28	22 x 28	6	RFGD05E-19.0-653	10205064202
		9 -	M22/28	22 x 28	6	RFGD05E-23.0-655	10205064402
		9 -	M22/35	22 x 35	6	RFGD05E-23.0-666	10205065002



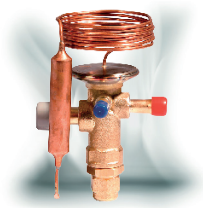

SANHUA RFGD SERIES

Thermostatic Expansion Valve

RFGD STANDARD RANGE

D) Models with Imperial Connections

RFGD10 (orifice 1-6) -40°C to +10°C (Models without MOP)

Refr.	MWP [MPa]	Valve Body	Capacity Size All Sizes	Connections IN x OUT		Pressure Equal. [mm]	Model Name	Product Number U11 Code Multi-Pack
				Metric	[mm]			
R407C	2,8	RFGD 02E -	1 -	3/5	3/8 x 5/8	1/4	RFGD 02E-3.1-33	10205008402
			2 -	4/7	1/2 x 7/8	1/4	RFGD 02E-4.2-34	10205007002
			3 -	4/7	1/2 x 7/8	1/4	RFGD 02E-6.3-35	10205008502
			4 -	5/7	5/8 x 7/8	1/4	RFGD 02E-8.1-36	10205007802
			5 -	5/7	5/8 x 7/8	1/4	RFGD 02E-9.4-37	10205007902
			6 -	5/7	5/8 x 7/8	1/4	RFGD 02E-11.7-38	10205008002
R404A / R507	3,5	RFGD 03E -	1 -	3/5	3/8 x 5/8	1/4	RFGD 03E-2.0-39	10205008102
			2 -	4/7	1/2 x 7/8	1/4	RFGD 03E-2.8-40	10205008202
			3 -	4/7	1/2 x 7/8	1/4	RFGD 03E-4.2-41	10205008302
			4 -	5/7	5/8 x 7/8	1/4	RFGD 03E-5.4-42	10205008602
			5 -	5/7	5/8 x 7/8	1/4	RFGD 03E-6.4-43	10205008702
			6 -	5/7	5/8 x 7/8	1/4	RFGD 03E-7.8-44	10205008802
R134a	2,1	RFGD 04E -	1 -	3/5	3/8 x 5/8	1/4	RFGD 04E-1.8-01	10205026702
			2 -	4/7	1/2 x 7/8	1/4	RFGD 04E-2.5-02	10205026702
			3 -	4/7	1/2 x 7/8	1/4	RFGD 04E-3.6-03	10205026902
			4 -	5/7	5/8 x 7/8	1/4	RFGD 04E-4.6-04	10205027002
			5 -	5/7	5/8 x 7/8	1/4	RFGD 04E-5.5-49	10205008902
			6 -	5/7	5/8 x 7/8	1/4	RFGD 04E-6.8-32	10205004402
R410A	4,5	RFGD 05E -	1 -	3/5	3/8 x 5/8	1/4	RFGD 05E-3.5-22	10205002502
			2 -	4/7	1/2 x 7/8	1/4	RFGD 05E-4.5-23	10205002702
			3 -	4/7	1/2 x 7/8	1/4	RFGD 05E-7.0-24	10205002802
			4 -	5/7	5/8 x 7/8	1/4	RFGD 05E-8.6-25	10205002902
			5 -	5/7	5/8 x 7/8	1/4	RFGD 05E-10.6-27	10205003102
			6 -	5/7	5/8 x 7/8	1/4	RFGD 05E-12.8-26	10205003002



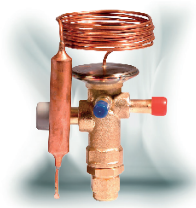

SANHUA RFGD SERIES

Thermostatic Expansion Valve

RFGD STANDARD RANGE

E) Models with Imperial Connections

RFGD20 (orifice 7-9) -40°C to +10°C (Models without MOP)

Refr.	Valve Body	Capacity Size All Sizes	Connections IN x OUT		Pressure Equal. [mm]	Model Name	Product Number U11 Code Multi-Pack
			Metric	[mm]			
R407C	RFGD 02E -	7 -	5/7	5/8 x 7/8	1/4	RFGD02E-12.0-542	10205057302
		7 -	5/9	5/8 x 1-1/8	1/4	RFGD02E-12.0-543	10205057402
		8 -	5/9	5/8 x 1-1/8	1/4	RFGD02E-15.0-545	10205057602
		8 -	7/9	7/8 x 1-1/8	1/4	RFGD02E-15.0-547	10205057802
		9 -	7/9	7/8 x 1-1/8	1/4	RFGD02E-18.0-549	10205058002
		9 -	7/11	7/8 x 1-3/8	1/4	RFGD02E-18.0-551	10205058202
R404A / R507	RFGD 03E -	7 -	5/7	5/8 x 7/8	1/4	RFGD03E-9.0-532	10205056302
		7 -	5/9	5/8 x 1-1/8	1/4	RFGD03E-9.0-533	10205056402
		8 -	5/9	5/8 x 1-1/8	1/4	RFGD03E-11.0-535	10205056602
		8 -	7/9	7/8 x 1-1/8	1/4	RFGD03E-11.0-537	10205056802
		9 -	7/9	7/8 x 1-1/8	1/4	RFGD03E-13.0-539	10205057002
		9 -	7/11	7/8 x 1-3/8	1/4	RFGD03E-13.0-541	10205057202
R134a	RFGD 04E -	7 -	5/7	5/8 x 7/8	1/4	RFGD04E-8.0-501	10205054102
		7 -	5/9	5/8 x 1-1/8	1/4	RFGD04E-8.0-502	10205054202
		8 -	5/9	5/8 x 1-1/8	1/4	RFGD04E-10.0-504	10205054402
		8 -	7/9	7/8 x 1-1/8	1/4	RFGD04E-10.0-520	10205054602
		9 -	7/9	7/8 x 1-1/8	1/4	RFGD04E-12.0-522	10205054802
		9 -	7/11	7/8 x 1-3/8	1/4	RFGD04E-12.0-524	10205055002
R410A	RFGD 05E -	7 -	5/7	5/8 x 7/8	1/4	RFGD05E-15.0-510	10205058302
		7 -	5/9	5/8 x 1-1/8	1/4	RFGD05E-15.0-511	10205058402
		8 -	5/9	5/8 x 1-1/8	1/4	RFGD05E-19.0-512	10205058602
		8 -	7/9	7/8 x 1-1/8	1/4	RFGD05E-19.0-517	10205058802
		9 -	7/9	7/8 x 1-1/8	1/4	RFGD05E-23.0-555	10205059002
		9 -	7/11	7/8 x 1-3/8	1/4	RFGD05E-23.0-557	10205059202



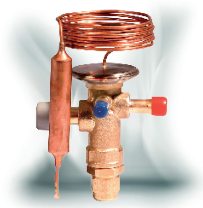

SANHUA RFGD SERIES

Thermostatic Expansion Valve

RFGD STANDARD RANGE

F) Models with Imperial Connections

RFGD20 (orifice 7-9) -25°C to +10°C with MOP +15°C

Refr.	Valve Body	Capacity Size All Sizes	Connections IN x OUT		Pressure Equal. [mm]	Model Name	Product Number U11 Code Multi-Pack
			Metric	[mm]			
R407C	RFGD 02E -	7 -	5/7	5/8 x 7/8	1/4	RFGD02E-12.0-637	10205062602
		7 -	5/9	5/8 x 1-1/8	1/4	RFGD02E-12.0-638	10205062702
		8 -	5/9	5/8 x 1-1/8	1/4	RFGD02E-15.0-640	10205062902
		8 -	7/9	7/8 x 1-1/8	1/4	RFGD02E-15.0-642	10205063102
		9 -	7/9	7/8 x 1-1/8	1/4	RFGD02E-18.0-644	10205063302
		9 -	7/11	7/8 x 1-3/8	1/4	RFGD02E-18.0-646	10205063502
R404A / R507	RFGD 03E -	7 -	5/7	5/8 x 7/8	1/4	RFGD03E-9.0-627	10205061602
		7 -	5/9	5/8 x 1-1/8	1/4	RFGD03E-9.0-628	10205061702
		8 -	5/9	5/8 x 1-1/8	1/4	RFGD03E-11.0-630	10205061902
		8 -	7/9	7/8 x 1-1/8	1/4	RFGD03E-11.0-632	10205062102
		9 -	7/9	7/8 x 1-1/8	1/4	RFGD03E-13.0-634	10205062302
		9 -	7/11	7/8 x 1-3/8	1/4	RFGD03E-13.0-636	10205062502
R134a	RFGD 04E -	7 -	5/7	5/8 x 7/8	1/4	RFGD04E-8.0-601	10205051202
		7 -	5/9	5/8 x 1-1/8	1/4	RFGD04E-8.0-602	10205059302
		8 -	5/9	5/8 x 1-1/8	1/4	RFGD04E-10.0-604	10205059502
		8 -	7/9	7/8 x 1-1/8	1/4	RFGD04E-10.0-606	10205059702
		9 -	7/9	7/8 x 1-1/8	1/4	RFGD04E-12.0-608	10205059902
		9 -	7/11	7/8 x 1-3/8	1/4	RFGD04E-12.0-610	10205060102
R410A	RFGD 05E -	7 -	5/7	5/8 x 7/8	1/4	RFGD05E-15.0-647	10205063602
		7 -	5/9	5/8 x 1-1/8	1/4	RFGD05E-15.0-648	10205063702
		8 -	5/9	5/8 x 1-1/8	1/4	RFGD05E-19.0-650	10205063902
		8 -	7/9	7/8 x 1-1/8	1/4	RFGD05E-19.0-652	10205064102
		9 -	7/9	7/8 x 1-1/8	1/4	RFGD05E-23.0-654	10205064302
		9 -	7/11	7/8 x 1-3/8	1/4	RFGD05E-23.0-656	10205064502



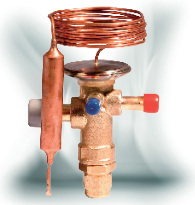

SANHUA RFGD SERIES

Thermostatic Expansion Valve

RFGD STANDARD RANGE

G) Models with Flare Connections

RFGD20 -40°C to +10°C without MOP

Model Name							
Refr.	Valve Body	Capacity Size All Sizes	Connections			Model Name	Product Number U11 Code Multi-Pack
			Flare	INxOUTxE	Flare Type		
R134a	RFGD 04E -	7 -	15/6	5/8×3/4×1/4	MIOxMIOxMIO	RFGD04E-8.0-525	10205055102
		8 -	15/6	5/8×3/4×1/4	MIOxMIOxMIO	RFGD04E-10.0-526	10205055202
		8 -	S5/6	5/8×3/4×1/4	SAExSAExSAE	RFGD04E-10.0-527	10205055302
		9 -	15/6	5/8×3/4×1/4	MIOxMIOxMIO	RFGD04E-12.0-528	10205055402

Connections: 1) MIO: Inlet = 7/8-14UNF-2A ; Outlet = 17/16-14UNS-2A ; Ext. Equalization port = 7/16-20UNF-2A
 2) SAE: Inlet = 7/8-14UNF-2A ; Outlet = 17/16-14UNS-2A ; Ext. Equalization port = 7/16-20UNF-2A

H) Models with Flare Connections

RFGD20 -25°C to +10°C with MOP +15°C

Model Name							
Refr.	Valve Body	Capacity Size All Sizes	Connections			Model Name	Product Number U11 Code Multi-Pack
			Flare	INxOUTxE	Flare Type		
R134a	RFGD 04E -	7 -	15/6	5/8×3/4×1/4	MIOxMIOxMIO	RFGD04E-8.0-611	10205051902
		7 -	S5/6	5/8×3/4×1/4	SAExSAExSAE	RFGD04E-8.0-612	10205060202
		8 -	15/6	5/8×3/4×1/4	MIOxMIOxMIO	RFGD04E-10.0-613	10205052002
		8 -	S5/6	5/8×3/4×1/4	SAExSAExSAE	RFGD04E-10.0-614	10205060302
		9 -	S5/6	5/8×3/4×1/4	SAExSAExSAE	RFGD04E-12.0-615	10205060402
		9 -	O5/6	5/8×3/4×1/4	ORFSxORFSxSAE	RFGD04E-12.0-616	10205060502

Connections: 1) MIO: Inlet = 7/8-14UNF-2A ; Outlet = 17/16-14UNS-2A ; Ext. Equalization port = 7/16-20UNF-2A
 2) SAE: Inlet = 7/8-14UNF-2A ; Outlet = 17/16-14UNS-2A ; Ext. Equalization port = 7/16-20UNF-2A
 3) ORFS: Inlet = 1-14UNS-2A; Outlet = 1-3/16-12UN-2A; Ext. Equalization port = 7/16-20UNF-2A



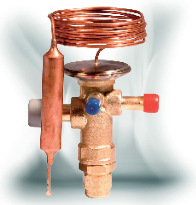

SANHUA RFGD SERIES Thermostatic Expansion Valve

DIMENSIONS

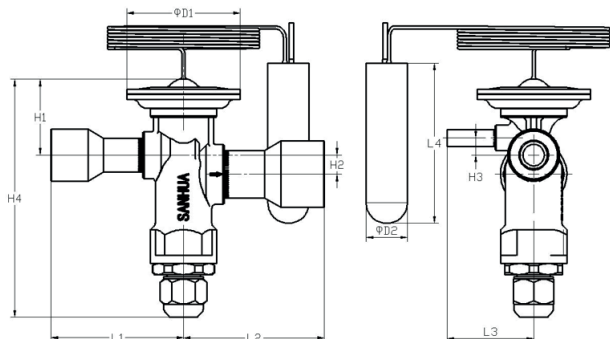

Model	Connections		Capillary	Dimensions									
	Imperial	Metric		H1	H2	H3	H4	L1	L2	L3	L4	ΦD1	ΦD2
	[inch]	[mm]	[m]	[mm]	[mm]	[mm]	[mm]	[mm]	[mm]	[mm]	[mm]	[mm]	[mm]
RFGD10	3/8×5/8	10×16	1.5	30	7.5	5	97	41.5	45.5	37.5	64	48	14.4
	1/2×7/8	12×22						41.5	59.5				
	5/8×7/8	16×22						45.5	59.5				
RFGD20	5/8×7/8	16×22	1.5	32	9	8	111	48	62	40.5	75	53	19.2
	5/8×1-1/8	16×28						48	66				
	7/8×1-1/8	22×28						62	66				
	7/8×1-3/8	22×35						62	66				

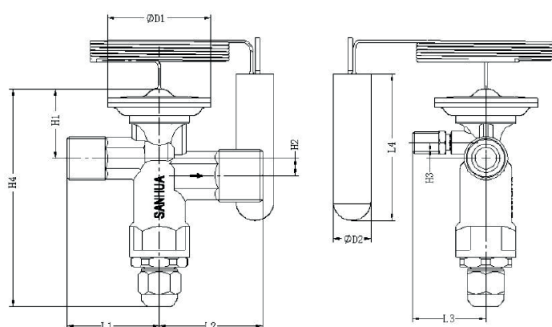

Model	Connections		Capillary	Dimensions									
	Flare			H1	H2	H3	H4	L1	L2	L3	L4	ΦD1	ΦD2
	Inlet x Out x Ext. E		[m]	[mm]	[mm]	[mm]	[mm]	[mm]	[mm]	[mm]	[mm]	[mm]	[mm]
RFGD20	5/8×3/4×1/4MIO	5/8×3/4 ORFS×1/4	1.5	32	9	8	111	47.5	53	37.7	75	53	19.2
	5/8×3/4×1/4SAE												
	5/8×3/4 ORFS×1/4												



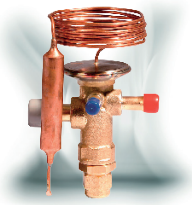

SANHUA RFGD SERIES Thermostatic Expansion Valve

NECESSARY INFORMATION FOR RFGD CUSTOMIZATION

Please specify all mandatory information in the customization table below. The standard RFGD features will be used if fields aren't filled in.

Pos.	Mandatory information	
5	Connections	
	Metrical	Imperial
	o Inlet 10mm, Outlet 16mm	o Inlet 3/8", Outlet 5/8"
	o Inlet 12mm, Outlet 22mm	o Inlet 1/2", Outlet 7/8"
	o Inlet 12mm, Outlet 22mm Ext. pressure equal. 6mm if selected	o Inlet 5/8", Outlet 7/8" Ext. pressure equal. 1/4" if selected
	Other connections	
	Inlet:	_____
	Outlet:	_____
	Ext. pressure equal.:	_____
Pos.	Additional information	
6	Static superheat: Factory Setting	
	Capacité	
	o 3...4K (Standard)	o Other value: _____ K
7	MOP	
	o Without (Standard)	o MOP point: _____ °C
8	Bleed	
	o Without (Standard)	o 15% Bleed o 30% Bleed
9	Designated application / other requirements	

